

E540



 Bluetooth®

Compact size!

Fits most machine types also when space is limited.

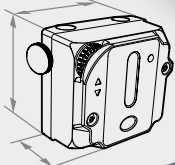

SHAFT ALIGNMENT

Professional measurement and alignment system for rotating machines

EASY-LASER®



SIMPLY EFFICIENT!

OPTIMIZE OPERATING CONDITIONS

Easy-Laser® E540 is a precise and competent alignment system for your rotating machinery. Easy-Laser® E540 provides the ideal balance between performance and price allowing you to create the best conditions to operate your machinery economically and problem-free:

- Keep track of machinery status with vibration level check*.
- Check the prerequisites for a correct alignment before aligning, e.g. bearing play and soft foot.
- Measure and align in three easy steps.
- Document the result.

Easy-Laser® is a cost effective investment that will pay itself back quickly by eliminating unplanned downtime, and reducing energy consumption and the need for spare parts. Simply efficient!



HORIZONTAL MACHINES

Pumps, motors, gear boxes, compressors etc.



VERTICAL/FLANGE-MOUNTED MACHINES

Pumps, motors, gear boxes, etc.



MACHINE TRAINS (3 MACHINES)

Pumps, motors, gear boxes, compressors etc.



BELT TRANSMISSIONS*

V-belts, Timing belts, Flat belts, Chain drives, etc.



VIBRATION MEASUREMENT*

Check vibration levels and bearing condition.



VALUES – DIGITAL DIAL INDICATOR

Versatile measurement program.

EASY-LASER® E540 HIGHLIGHTS

- Easy to learn and to use.
- Compact measuring units for use on most machine designs.
- All wireless units (Built-in Bluetooth® technology and integrated rechargeable battery).
- Large 5.7" colour display.
- Programs with both symbols and text = easy to understand.
- TruePSD technology with unlimited resolution.
- Dual PSD, dual laser beams and dual inclinometers for superior control and accuracy.
- Produce PDF reports directly from the Display unit and save to USB memory.
- 3 year warranty gives assurance.
- Fast service and support. 48-hours Express service if necessary.
- Low overall costs during the entire lifecycle of the product, for example servicing, accessories, etc.
- Expandable / Adaptable. A range of accessories means that you can adapt the measurement system to your needs, now and in the future.



Easy-Laser® is used to align generators and gearboxes in wind turbines of a number of sizes and makes. Special brackets are available for alignment with locked rotors to increase the safety of the operator.



Engines, gearboxes and propeller shafts on ships are aligned using the Easy-Laser® system. Thanks to flexible brackets you can install the equipment in the most appropriate place; shaft, coupling, or flywheel.



Easy-Laser® is used to align pumps and motors for all types of installations in a variety of industries. Correctly set-up and aligned machines are necessary to reduce energy consumption and achieve optimum service life.

*Accessories required

EASY TO USE

HARDWARE AND SOFTWARE IN PERFECT HARMONY

Alignment should be easy! That is the fundamental philosophy behind our measurement systems. The simple mounting system and straightforward user interface make the Easy-Laser® E540 easy to learn, easy to understand and easy to use!

EASY TO USE = FAST RESULTS

- Mount the equipment quickly with the pre-mounted units.
- Enter all machine data with the barcode reader.*
- Start measurement anywhere on the revolution, without the need for an exact position, then turn a minimum 20° to the next position.
- Adjust the machine in live mode in both Horizontal and Vertical directions.
- Save the measurement. A PDF with all measurement data is automatically generated.



BARCODE READER

The barcode reader is used to enter the machine data before measurement is taken. After the first measurement is recorded, the adhesive barcode label is applied to the machine. Next time the machine is checked, the measurements, compensation values and tolerances can be read directly from the barcode. Simple and accurate! (*Barcode reader is accessory.)



DOCUMENTATION

CREATE A PDF REPORT

Generate a PDF report containing graphs and measurement data directly in the measurement system's display unit.

SAVE IN BUILT-IN MEMORY

Save all measurements in the display unit's internal memory.

SAVE TO USB MEMORY

Save desired measurements on your USB memory. This enables you to take it to your computer to print reports whilst leaving the measurement system in place.

CONNECT TO YOUR COMPUTER

The display unit is connected to the computer via the USB port. It then appears on the desktop as a USB Mass Storage Device from which you can easily transfer files.

MAKE A PRINTOUT

Quickly print all measurement data locally with a thermal printer (accessory).

EASYLINK™ PC SOFTWARE

With the EasyLink™ database program you can save and organise all your measurements in one place, produce reports with both data and images and export to your maintenance systems.



PROGRAMS AND FUNCTIONS

HORIZONTAL MACHINES



Horizontally mounted machines often consist of a pump and a motor, but can also include other types of machines such as gearboxes and compressors. Regardless of the machine type, it is easy to measure and align with Easy-Laser®. The measuring units (M and S) are easily mounted on each side of the coupling and communicate with the display unit wireless. Then follow the step-by-step instructions on screen (see below).

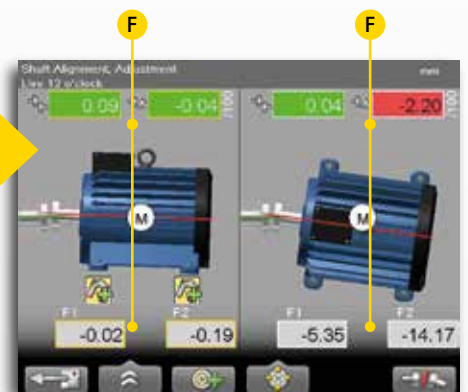
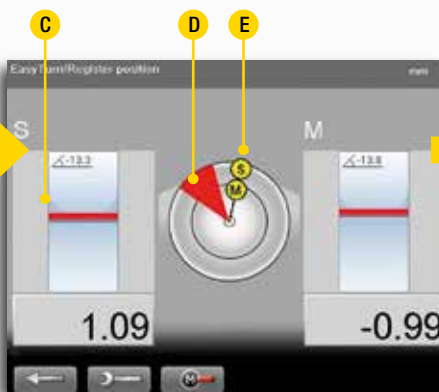
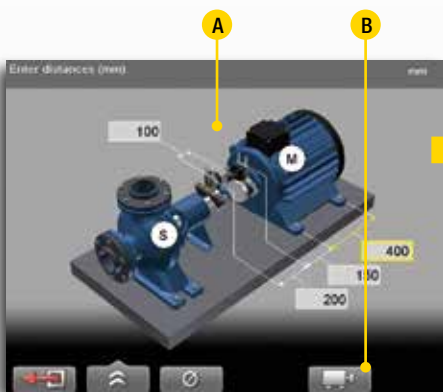

1. Enter the distances between measuring units and the machine feet. If you enter the coupling diameter you can also get the result as gap/sag.

A. You can start from a previous measurement and so avoid re-entering the dimensions.

B. Swap view function: movable machine displayed to the left or right.

2. Take the measurement values in three positions with as little as 20° between.

C. The detector surface is shown on the screen and functions as an electronic target for the laser beams.

D. 20° marking.

E. The measuring units position is shown.

3. The live values reflect the adjustments made to the machine. For clarity, the adjustment is displayed both graphically and numerically. Horizontal and Vertical directions are shown at the same time.

F. Shims values and horizontal adjustment values. Offset and angular values are colour coded in order to determine the result more quickly: red=outside tolerance, green=inside tolerance.

SOFT FOOT CHECK



Alignment work begins with a soft foot check. The soft foot check ensures that the machine is resting evenly on all its feet by indicating which foot/feet should be adjusted. This is an important part of securing a reliable alignment. After the soft foot check is complete, you can go directly to the alignment program with all of the machine's distance values saved.

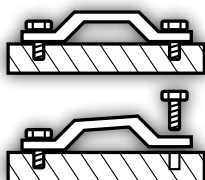

EASYTURN™ FUNCTION



The EasyTurn™ function allows you to begin the measurement process from anywhere on the turn. You can turn the shaft to any three positions with as little as 20° between each position to register the measurement values. Voila! Measurement is complete!

Start measurement at any position!

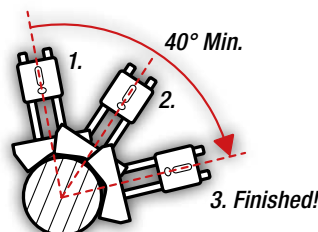

THERMAL GROWTH COMPENSATION



Oftentimes, machines expand considerably when moving from a cold to hot operating temperature. The Thermal Growth Compensation function allows the measurement system to calculate the appropriate shims and values needed to make adjustments in such cases. Compensation values for the machines are normally supplied by the manufacturers.

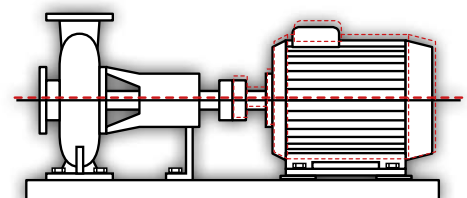

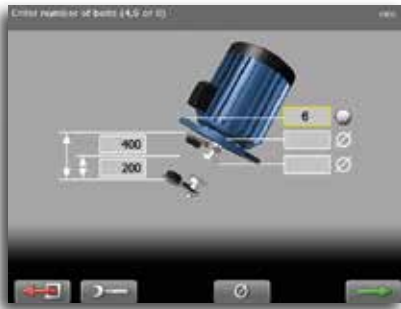

VERTICAL MACHINES



Alignment of vertical and flange-mounted machines. Shows centre offset, angular error and shim value at each bolt.

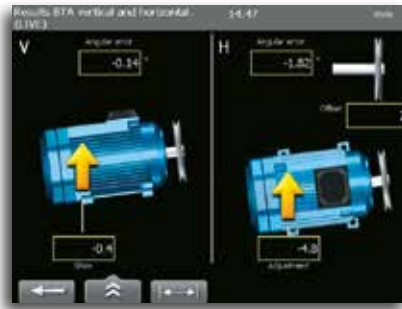

BELT ALIGNMENT



The Belt Alignment program allows you to align sheaves and pulleys with digital precision. Adjustment values are displayed in real time on the screen and include readings for angle and axial displacement in both vertical and horizontal positions, as well as an adjustment value for the feet. The result can be documented as usual. (Requires the E170 or E180 BTA accessory.)



VIBRATION MEASUREMENT



The Vibration Measurement program allows you to measure vibration levels (mm/s, inch/s) and bearing condition (g-value). The program guides the user through the vertical, horizontal and axial points to measure on the machine. The result can be documented as usual. (Requires the E285 Vibrometer probe accessory.)



MACHINE TRAIN



For alignment of machine trains with three machines. You can pick the reference machine manually, or let the program choose one that will minimize the need for adjustments.

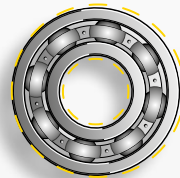

VALUES PROGRAM



The Values program can be used e.g. when one wants to measure as with dial gauges and to check bearing play. With the standard equipment and completely normal set up on the machine!

TOLERANCE CHECK



Measurement results can be checked against pre-defined tolerance tables or values you determine yourself. This allows you to immediately see if the alignment is within the approved parameters, thereby considerably reducing the amount of time spent on alignment.

REFERENCE FOOT LOCKING



This function allows you to lock any pair of feet on the machine, giving you more freedom when aligning base-bound or bolt-bound machines.

MEASUREMENT VALUE FILTER



An advanced electronic filter function can be used to achieve reliable results even under poor measuring conditions. Air turbulence and vibrations from adjacent machines are no match for the Easy-Laser® E540 advanced filter function!

LIVE-ANY-ANGLE 360°



This function allows you to adjust machines in real time with the measuring units positioned anywhere on the shaft. It is ideal for situations in which outside objects interfere with normal positioning.

MULTIPLE SETS OF FEET



The software can adjust to machine designs of all types such as those with two pairs of feet, three pairs of feet, and feet in front of the coupling, etc.

SWAP VIEW FUNCTION



The swap view function allows you to adjust the position of the motor on screen to correspond with the position of the machine in front of you, making it easier to understand adjustment directions.

SYSTEM PARTS



- A. Two Enter buttons, for left and right-handed users
- B. Large, easy to read 5.7" colour display
- C. Proper buttons for clear feedback

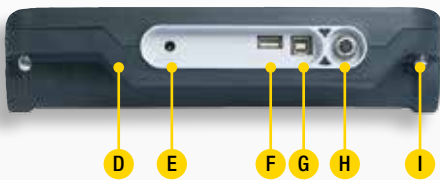

- D. Robust, rubber coated design
 - E. Connection for charger
 - F. USB A
 - G. USB B
 - H. Easy-Laser® measurement equipment
 - I. Mounting for shoulder strap
- Note: Dust and splash guard for connectors removed on picture.

DISPLAY UNIT

The display unit has a thin, easy-to-grip rubber coated exterior for secure handling. Enter buttons on each side make the system suitable for both right and left-handed users. The large well-spaced panel buttons correspond to clear graphics that guide you through the measurement process with ease.

LANGUAGE SELECTION

You can choose the language that you want to appear on screen. English, German, French, Spanish, Italian, Portuguese, Swedish, Finnish, Russian, Dutch, Polish, Japanese, Korean and Chinese are available. More languages to follow.

UPGRADING

If you wish to expand functionality, the display unit software can be upgraded via the internet or with a USB memory stick containing the new software. The upgrade feature also provides access to any new measurement programs we develop in the future.

FEATURES

- Robust, rubber coated design
- Large 5.7" colour display
- Language selection and symbols
- Guiding software
- Bar code reader support
- Save directly to PDF
- Large internal memory
- User profiles with your personal settings
- Integrated calculator
- Conversion tool for length units
- Upgradable
- USB interface

MEASURING UNITS

The measuring units have large detectors (TruePSD) that allow you to measure from distances up to 10 metres (33 feet). The substantial design made of aluminium and stainless steel guarantees precise measurement and reliable alignment in even the toughest environments. The measuring units are water and dust proof to class IP65.

ALWAYS WIRELESS CONNECTION

The measuring units are connected to the Display unit wirelessly, which gives you full freedom to move around your machines with the Display unit!

CHARGING

For charging, connect the two measuring units to the Display unit with the supplied splitter cable. This way you can also supply the measuring units with power during measurement, if needed.

FEATURES

- TruePSD technology with unlimited resolution for greatest accuracy.
- Large 30 mm detectors [1.2"].
- Dual laser beams and PSDs make it possible to also measure very incorrectly set machines. This is particularly useful for new installations, where the machines are not yet in the correct position.
- With electronic inclinometers in both measuring units, the system knows exactly how they are positioned making it easier to align uncoupled shafts.
- Pre-mounted units for quicker mounting.
- Electronic targets, that is you can see on the screen where the laser beams hit.
- Sturdy aluminium body.

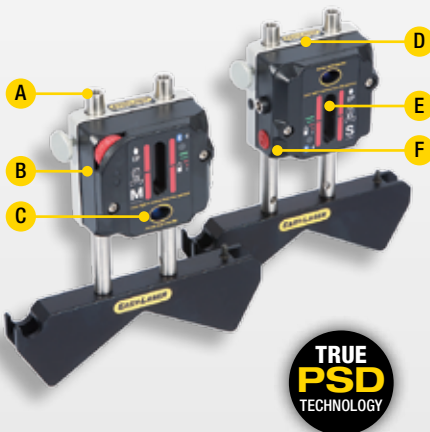

- A. The rods have a height of 60–180 mm. If necessary they can be extended "infinitely" with accessory rods. Made of stainless steel.
- B. Pre-mounted units/brackets
- C. Laser aperture
- D. Sturdy aluminium body
- E. PSD (30 mm/1.2")
- F. On/Off button

ACCESSORIES AND EXPANDABILITY

BELT ALIGNMENT



E180 BTA. Laser transmitter and Bluetooth® wireless detector for belt transmission alignment. With built-in display. Use it as a separate tool or connect it to the E540 for extended functionality. Part No. 12-0796

VIBRATION MEASUREMENT



E285 Vibrometer probe. For measuring vibration and bearing condition. For the connection, "red cable" pictured below is also needed. Part No. 12-0656

BRACKETS ETC.

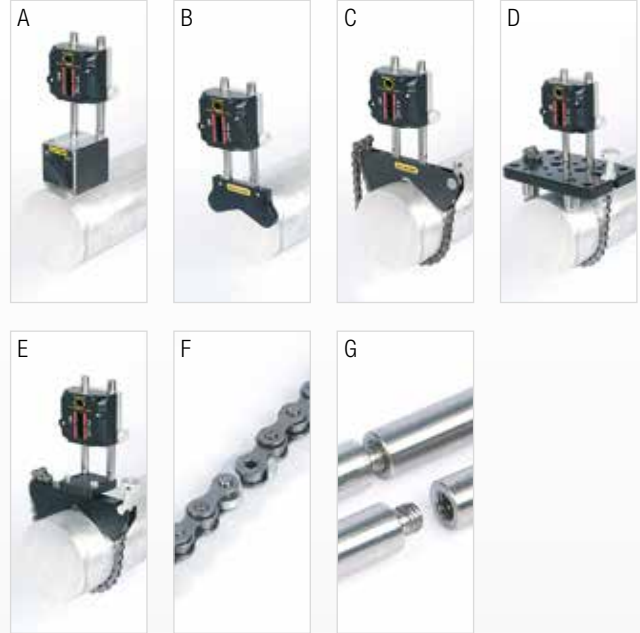

A. MAGNET BASE

For direct attachment to shaft or coupling. Very strong and stable. Three magnetic sides give flexible positioning possibilities. Part No. 12-0013

B. MAGNETIC BRACKET

Bracket for axial mounting on flange or shaft end. Includes four super magnets. Part No. 12-0413

C. THIN SHAFT BRACKET

This bracket is used when there is limited space between the coupling and the machine. Thin chain and lock tools included. Width: 12 mm [0.47"]. Part No. 12-0412

D. SLIDING BRACKET

Used when the shafts cannot be rotated. The spherical feet give a stable position against the shaft. Mounted with standard chains. Part No. 12-0039

E. OFFSET BRACKET

Allows axial displacement between measuring units in order to rotate beyond machine parts and connectors. Part No. 01-1165

F. EXTENSION CHAINS

Makes it possible to align very large shafts. Length: 900 mm [35.4"], (2 x) Part No. 12-0128

G. EXTENSION RODS

Screwed together. Extendable theoretically "unlimited".
Length 30 mm [1.18"], (1 x) Part No. 01-0938
Length 60 mm [2.36"], (4 x) Part No. 12-0059
Length 120 mm [4.72"], (8 x) Part No. 12-0324
Length 240 mm [9.44"], (4 x) Part No. 12-0060

BARCODE READER



Barcode reader for registration of machine data. Connected in the USB port. Part No. 12-0619

PROTECTIVE COVER



Protective case for display unit. With shoulder strap. Part No. 01-1379

CHARGER 12-36 V



To charge the display unit via 12-36 V socket, for example in a car. Part No. 12-0585

CABLE



For the connection of Vibrometer. Length 2 m [78.7"], Part No. 12-0074

TECHNICAL DATA



Extend the warranty from 2 to 3 years by registering your system on the Internet.

System	
Relative humidity	10–95%
Weight (complete system)	7.2 kg [15.9 lbs]
Carrying case	WxHxD: 500x415x170 mm [19.7"x16.3"x6.7"]

Measuring units ELM40 / ELS40

Type of detector	True PSD 30 mm [1.2"]
Wireless communication	Class I Bluetooth® wireless technology
Operating time	>4 h
Resolution	0.001 mm [0.05 mils]
Measuring errors	±1% +1 digit
Measurement range	Up to 10 m [33 feet]
Type of laser	Diode laser
Laser wavelength	635–670 nm
Laser class	Safety class II
Laser output	<1 mW
Electronic inclinometer	0.1° resolution
Thermal sensors	-20–60 °C
Environmental protection	IP class 65
Temperature range	-10–50 °C
Housing material	Anodized aluminium / ABS plastics
Dimensions	WxHxD: 69.0x61.5x41.5 mm [2.72"x2.42"x1.63"]
Weight	172 g [6.0 oz]

Display unit E52

Type of display/size	VGA 5.7" colour screen, backlit LED
Displayed resolution	0.001 mm / 0.05 thou
Internal battery (fixed)	Heavy duty Li Ion chargeable
Operating time	Approx. 30 hours (at typical user cycle)
Temperature range	-10–50 °C
Connections	USB A, USB B, Easy-Laser® units, Charger
Wireless communication	Class I Bluetooth® wireless technology
Internal memory	>100 000 measurements can be saved
Help functions	Calculator, Unit converter
Environmental protection	IP class 65
Housing material	PC/ABS + TPE
Dimensions	WxHxD: 250x175x63 mm [9.8"x6.9"x2.5"]
Weight	1020 g [2.3 lbs]

Cables

Charging cable (splitter cable)	Length 1 m [39.4"]
USB cable	Length 1.8 m [70.8"]

Brackets etc.

Shaft brackets	Type: V-fixture for chain, width 18 mm [0.7"]. Shaft diameters: 20–450 mm [0.8"–17.7"] Material: anodised aluminium
Rods	Length: 120 mm, 60 mm [4.72", 2.36"] (extendable) Material: Stainless steel

EasyLink™ Data base software

System requirements	Windows® XP, Vista, 7, 8. For the export functions, Excel 2003 or newer must be installed on the PC.
---------------------	--

A complete system contains

1	Measuring unit M
1	Measuring unit S
1	Display unit
2	Shaft brackets with chains
2	Extension chains
4	Rods 120 mm [4.72"]
4	Rods 60 mm [2.36"]
1	Measuring tape 3 m [9.8"]
1	USB memory with EasyLink™ PC software
1	USB cable
1	Charger (100–240 V AC)
1	DC split cable for charging
1	DC to USB adapter, for charging
1	Shoulder strap for display unit
1	Quick reference manual
1	CD with documentation
1	Carrying case

System Easy-Laser® E540 Shaft, Part No. 12-0775



The case is pre-cut for accessories:

- A. Barcode reader
- B. Magnetic brackets
- C. E180 BTA or E170 BTA
- D. E285 Vibrometer
- E. Magnet bases
- F. Offset brackets

Easy-Laser® is manufactured by Damalini AB, Alfagatan 6, SE-431 49 Mölndal, Sweden
Tel +46 (0)31 708 63 00, Fax +46 (0)31 708 63 50, e-mail: info@damalini.se, www.damalini.com
© 2014 Damalini AB. We reserve the right to make changes without prior notification.
Easy-Laser® is a registered trademark of Damalini AB.
Other trademarks belong to the relevant copyright holder.
This product complies with: EN60825-1, 21 CFR 1040.10 and 1040.11.
This device contains FCC ID: PVH0925, IC: 5325A-0925.



ISO9001
CERTIFIED

05-0670 Rev2



J.L. Griffin LLC.
4625-B Turtle Creek Drive,
Brookfield, WI 53005
TEL 414.218.8088
E-mail jim@jllgriffin.com